

Data Sheet for Precision Potentiometer

Conductive Plastic Potentiometer

Series SFCP22



The SFCP22 potentiometers in 22 mm metal housing are for applications where precise long-lasting and compact sensors are important.

- Very long lifespan 20 mio. rotations
- High accuracy
- Compact sensor
- 2 x ball bearings
- Optional rear shaft, center tap

Electrical Data

Effective electrical angle of rotation 1.)	320° ±5°
Total resistance 1.)	0,5..100 kOhm
Resistance tolerance	±5%
Independent linearity (best straight line) 1.)	±0,75% (±0,5%)
Theoretical resolution	Nearly infinite
Backlash (Hysteresis) 1.)	≤ 0,5°
Max. / recommended wiper current 1.)	10 µA / 2 µA
Power rating @ 70°C (0W @ 105°C)	1 W
Insulation Voltage 1.)	500 VAC, 1min
Insulation Resistance 1.)	1000 MOhm @ 500 VDC

Mechanical Data, Environmental Conditions, Miscellaneous

Mechanical angle of rotation	360° without stop
Lifetime (90% el. eff. angle half sine) 2.)	20 Mio. rotations
Max. operational speed	400 rev. / min.
Bearing	2 x ball bearing
Operational torque @ ambient temperature 1.) 2.)	5 Nmm
Operating temperature range	-55..+105°C
Storage temperature range	-55..+105°C
Protection grade (IEC 60529)	IP40
Vibration (IEC 68-2-6, Test Fc)	15g 10..2000Hz x 12h
Shock (IEC 68-2-27, Test Ea)	49g @ 11 ms x 18
Housing diameter	22 mm
Housing depth	20 mm
Shaft diameter	6,00 mm (optional 6,35 mm)
Shaft type	Solid shaft

Data Sheet for Precision Potentiometer

Conductive Plastic Potentiometer

Series SFCP22

Mechanical Data, Environmental Conditions, Miscellaneous

Max. radial load	≤1 N
Max. axial load	≤1 N
Connection type	Gold plated solder pins
Connection position	Axial
Sensor mounting	Servo flange
Mass	30 g
Fastening parts included in delivery	3 x servo clamps SFN2
Material shaft	Stainless steel
Material housing	Aluminium

1.) According IEC 60393

2.) Determined by climatic conditions according to IEC 68-1, para. 5.3.1 without load collectives

Please note: Max. permissible supply voltage <75 VDC respectively <50 VAC in addition the max. power rating must be observed

Order code

Description	Selection: standard=black/bold, possible options=grey/cursive						
Series	SFCP22						
Resistance value: <i>Option 500 Ohm</i>		<i>R500</i>					
1 kOhm <i>Option 2 kOhm</i>		R1k <i>R2k</i>					
5 kOhm 10 kOhm <i>Option 20 kOhm</i> <i>Option 50 kOhm</i> <i>Option 100 kOhm</i>		R5k R10k <i>R20K</i> <i>R50K</i> <i>R100K</i>					
<i>Option rear shaft:</i> <i>Standard Ø3,00 x 20 mm</i> <i>Shaft length in mm</i> <i>Shaft diameter in mm (≤3 mm)</i>			<i>RA</i> <i>RAxx,xx</i> <i>RADMx,xx</i>				
Resistance tolerance: ±5%				W5%			
Independent linearity: ±0,75% <i>Option ±0,5%</i>					L0,75% <i>L0,5%</i>		
<i>Option center tap:</i>						<i>CT</i>	
Option front shaft: Standard Ø6,00 x 11,5 mm <i>Option front shaft diameter Ø6,35 mm</i> <i>Option shaft length in mm</i> <i>Option shaft diameter in mm (≤6 mm)</i>							<i>-</i> <i>DM6,35</i> <i>Ax,xx</i> <i>DMx,xx</i>
<i>Option screwdriver slot standard:</i>							<i>B</i>

For higher quantities or on-going demand, additional options are available as described below on request

For Example: Sealed housing case, special electrical and mechanical angles of rotation, and special resistance and linearity tolerances. Furthermore we can mount gear wheels or attach cable assemblies with or without connectors and much more.

Data Sheet for Precision Potentiometer



Conductive Plastic Potentiometer

Series SFCP22

Drawing

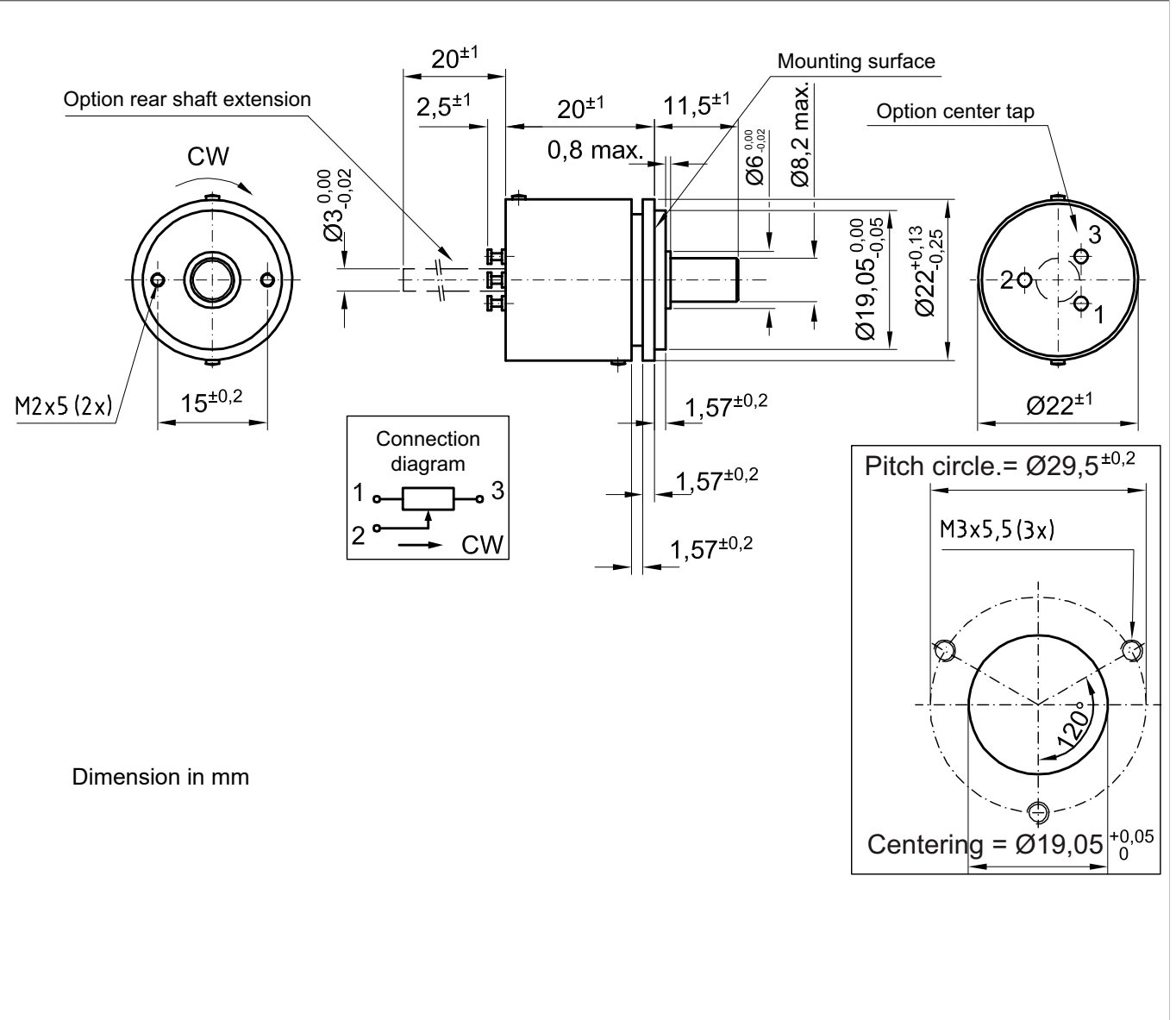

On Request: Special machining on shaft

Slot



Groove



Flat



Round top

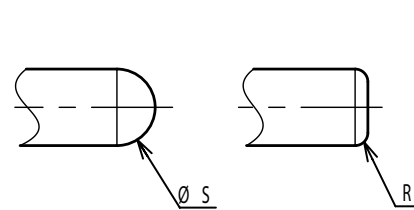

Double side flat

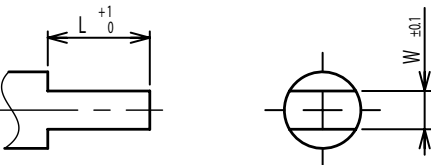

Counterbore hole

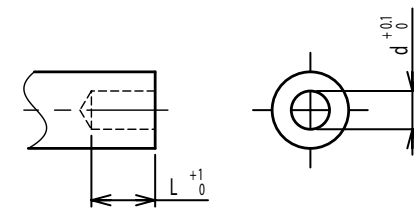

Step

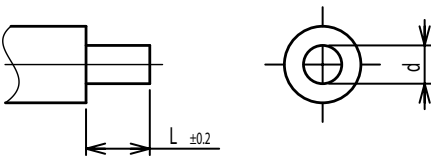

Counterbore screw hole

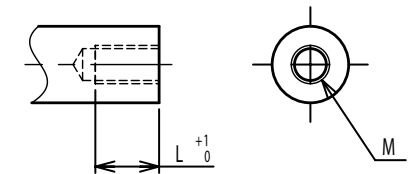

Screw Thread

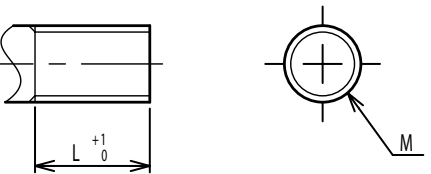

Pin hole

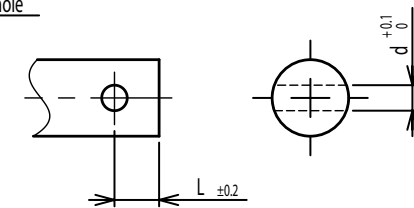

Knurled(Parallel)

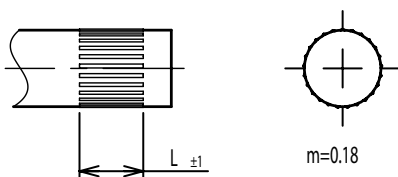

Screw thread inside hole

