

Data Sheet for Precision Potentiometer

Conductive Plastic Potentiometer

Series MPA20/21

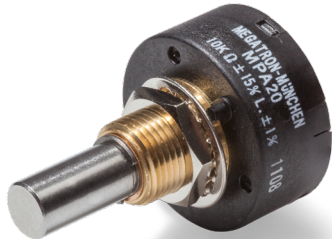

The MPA20/21 potentiometers in 22 mm housing are for applications where precise and long-lasting sensors are important.

- Long life and independent linearity ± 1 ($\pm 0,5\%$)
- With or without mechanical end stop ($320^\circ / 360^\circ$)

The conductive plastic potentiometer MPA20/21 (MPA21 with mech. endstop) are convincing due to their accuracy and long life due to the high-quality Comolded conductive plastic technology.

Note: The versions MPA21 with stop are also used as manual control

Electrical Data	MPA20	MPA21
Effective electrical angle of rotation 1.)	$340^\circ \pm 5^\circ$	$320^\circ \pm 5^\circ$
Total resistance 1.)	0,5..100 kOhm	
Resistance tolerance	$\pm 15\%$ ($\pm 10\%$)	
Independent linearity (best straight line) 1.)	$\pm 1\%$ ($\pm 0,5\%$)	
Theoretical resolution 1.)	Nearly infinite	
Backlash (Hysteresis) 1.)	$\leq 0,5^\circ$	
Max. / recommended wiper current 1.)	10 / 2 μA	
Power rating @ 70°C (0W @ 105°C)	1 W	
Insulation Voltage 1.)	500 VAC, 1min	
Insulation Resistance 1.)	1000 MOhm @ 500 VDC	

Mechanical Data, Environmental Conditions, Miscellaneous	MPA20	MPA21
Mechanical angle of rotation	360° without stop	$320^\circ + 10^\circ$ with stop
Lifetime (90% el. eff. angle half sine) 2.)	10 Mio. rotations	
Max. operational speed	400 rev. / min.	
Bearing	Sleeve bearing	
Operational torque @ ambient temperature 1.) 2.)	5 Nmm	
End stop torque 1.) 2.)	-	60 Ncm
Operating temperature range	$-55..+105^\circ\text{C}$	
Storage temperature range	$-55..+105^\circ\text{C}$	
Protection grade (IEC 60529)	IP40	
Protection option D shaft sealing (IEC 60529)	IP65 optional	
Vibration (IEC 68-2-6, Test Fc)	15g 10..2000Hz x 12h	
Shock (IEC 68-2-27, Test Ea)	49g @ 11 ms x 18	
Housing diameter	22 mm	
Housing depth	10,6 mm	
Shaft diameter	6,35 mm (optional 6,00 mm)	
Shaft type	Solid shaft	
Max. radial load	≤ 1 N	
Max. axial load	≤ 1 N	

Data Sheet for Precision Potentiometer

Conductive Plastic Potentiometer

Series MPA20/21

Mechanical Data, Environmental Conditions, Miscellaneous	MPA20	MPA21
Connection type	Gold plated soldering pins	
Connection position	Axial	
Sensor mounting	Bushing	
Mass	20 g	
Fastening parts included in delivery	Nut, toothed washer	
Fastening torque mounting nut	150 Ncm	
Material shaft	Stainless steel	
Material housing	Reinforced fibreglass PA66	

1.) According IEC 60393

2.) Determined by climatic conditions according to IEC 68-1, para. 5.3.1 without load collectives

Please note: Max. permissible supply voltage <75 VDC respectively <50 VAC in addition the max. power rating must be observed

Order code

Description	Selection: standard=black/bold, possible options=grey/cursive									
Series	MPA									
Angle of rotation with / without mecha. Stop:										
Without stop		20								
With stop		21								
Resistance value:										
<i>Option 500 Ohm</i>			<i>R500</i>							
1 kOhm			R1k							
<i>Option 2 kOhm</i>			<i>R2k</i>							
5 kOhm			R5k							
10 kOhm			R10k							
<i>Option 20 kOhm</i>			<i>R20K</i>							
<i>Option 50 kOhm</i>			<i>R50K</i>							
<i>Option 100 kOhm</i>			<i>R100K</i>							
Resistance tolerance:										
±15%					W15%					
<i>Option ±10%</i>					<i>W10%</i>					
Independent linearity:										
±1%						L1%				
<i>Option ±0,5%</i>						<i>L0,5%</i>				
<i>Option center tap:</i>								<i>CT</i>		
Option front shaft:										
Standard Ø6,35 x 22,2 mm (Bushing 3/8" 32UNEF)									-	
<i>Option front shaft diameter Ø6 mm (Bushing M9x0,75)</i>									<i>DM6,00</i>	
<i>Option shaft length in mm</i>									<i>Ax,xx</i>	
<i>Option shaft diameter in mm (<6,35 mm) (Bushing M9x0,75)</i>									<i>DMx,xx</i>	
<i>Option screwdriver slot standard:</i>										<i>B</i>
Shaft sealing:										
Standard is without sealing										-
<i>Option D with shaft sealing</i>										<i>D</i>

For higher quantities or on-going demand, additional options are available as described below on request

For Example: Sealed housing case, special electrical angles of rotation, and special resistance and linearity tolerances. Furthermore we can mount gear wheels or attach cable assemblies with or without connectors and much more.

Data Sheet for Precision Potentiometer



Conductive Plastic Potentiometer

Series MPA20/21

Drawing

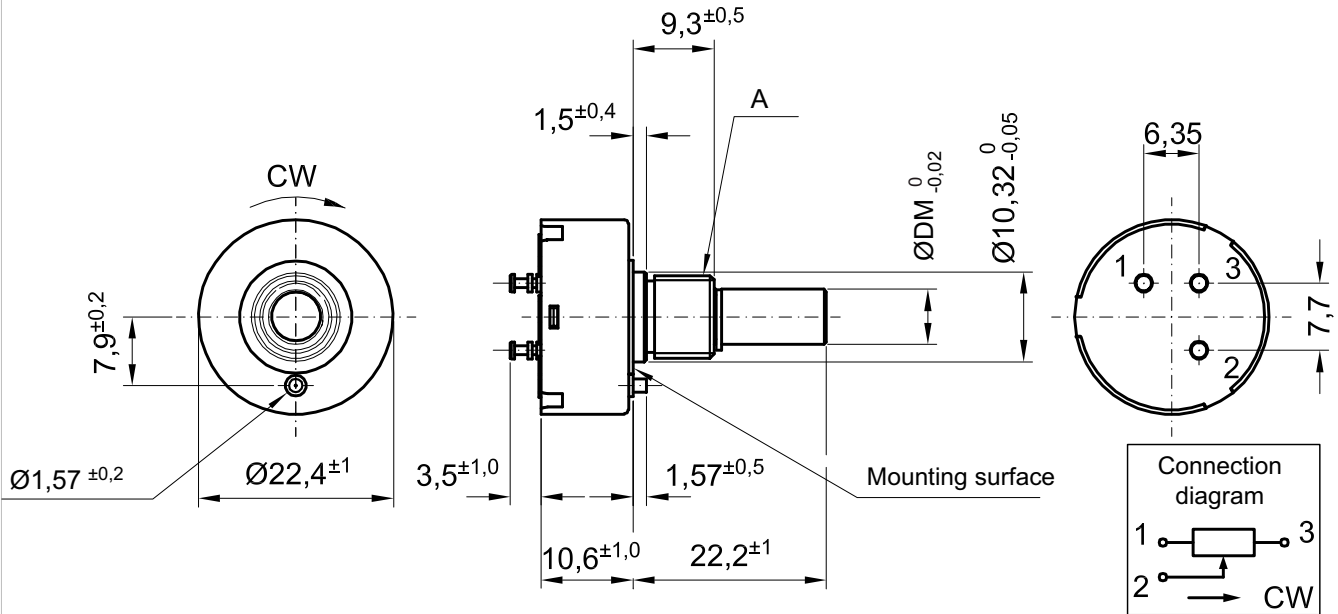

\varnothing DM - Shaft	A - Bushing
6,35	3/8" 32UNEF
6,00	M9x0,75
DMx,xx	M9x0,75

Dimensions in mm

On Request: Special machining on shaft

Slot

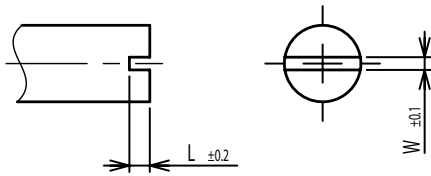

Groove

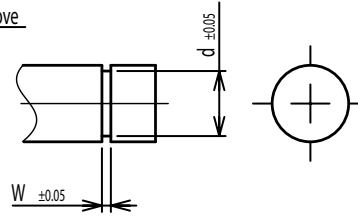

Flat

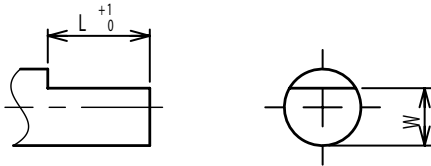

Round top

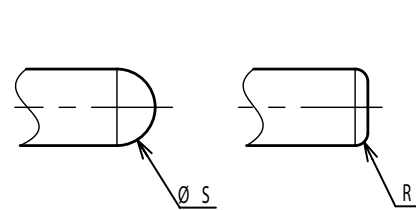

Double side flat

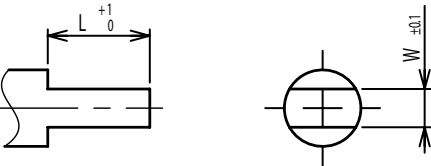

Counterbore hole

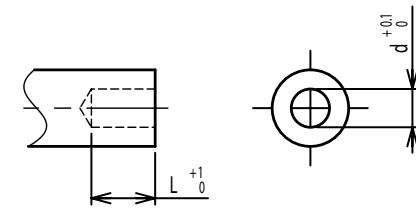

Step

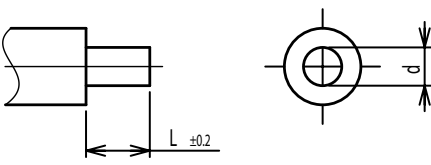

Counterbore screw hole

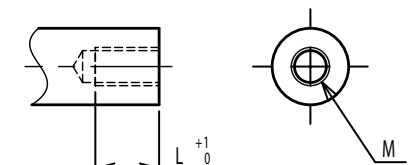

Screw Thread

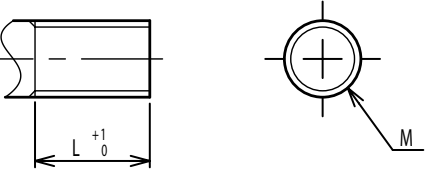

Pin hole

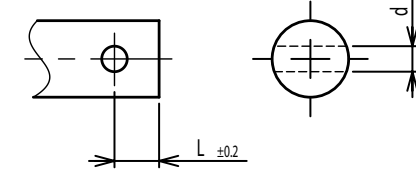

Knurled(Parallel)

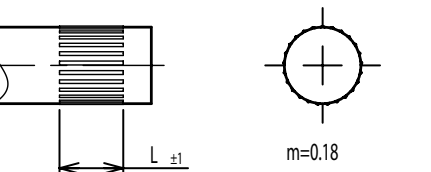

Screw thread inside hole

