

# Data Sheet for Precision Potentiometer

Conductive Plastic Potentiometer

Series MCP05



The MCP05 potentiometers in 13 mm housing with precision ball bearings and servo flange are suitable for applications where a precise miniaturized and long life sensor with precise mounting is important.

- Miniature housing with only Ø13 mm
- Ideal for confined spaces
- Servo flange for exact mounting
- 2 Precision ball bearings

The precision potentiometer series MCP05 is used as a precise and reliable miniature sensor for confined space conditions.

## Electrical Data

Effective electrical angle of rotation 1.)	300° ±5°
Total resistance 1.)	0,5..100 kOhm
Resistance tolerance	±10% (±15%)
Independent linearity (best straight line) 1.)	±1% (±2%)
Theoretical resolution 1.)	Nearly infinite
Backlash (Hysteresis) 1.)	≤ 0,5°
Max. / recommended wiper current 1.)	10 µA / 2 µA
Power rating @ 70°C (0W @ 105°C)	0,2 W
Insulation Voltage 1.)	500 VAC, 1min
Insulation Resistance 1.)	1000 MOhm @ 500 VDC

## Mechanical Data, Environmental Conditions, Miscellaneous

Mechanical angle of rotation	360° without stop
Lifetime (90% el. eff. angle half sine) 2.)	10 Mio. rotations
Max. operational speed	400 rev. / min.
Bearing	2 x ball bearing
Operational torque @ ambient temperature 1.) 2.)	1 Nmm
Operating temperature range	-55..+105°C
Storage temperature range	-55..+105°C
Protection grade (IEC 60529)	IP40
Vibration (IEC 68-2-6, Test Fc)	15g 10..2000Hz x 12h
Shock (IEC 68-2-27, Test Ea)	49g @ 11 ms x 18
Housing diameter	13 mm
Housing depth	12,5 mm
Shaft diameter	3 mm
Shaft type	Solid shaft
Max. radial load	≤1 N
Max. axial load	≤1 N

# Data Sheet for Precision Potentiometer

Conductive Plastic Potentiometer

Series MCP05

## Mechanical Data, Environmental Conditions, Miscellaneous

Connection type	Gold plated soldering pins
Connection position	Axial
Sensor mounting	Servo flange
Mass	ca. 5 g
Fastening parts included in delivery	3 servo clamps SFN3 with screw M1 1,6 x 3,5
Material shaft	Stainless steel
Material housing	Aluminium

1.) According IEC 60393

2.) Determined by climatic conditions according to IEC 68-1, para. 5.3.1 without load collectives

Please note: Max. permissible supply voltage <75 VDC respectively <50 VAC in addition the max. power rating must be observed

## Order code

Description	Selection: <b>standard=black/bold</b> , possible <i>options=grey/italic</i>						
<b>Series</b>	<b>MCP05</b>						
<b>Resistance value:</b>							
<i>Option 500 Ohm</i>		<i>R500</i>					
<b>1 kOhm</b>		<b>R1k</b>					
<i>Option 2 kOhm</i>		<i>R2k</i>					
<b>5 kOhm</b>		<b>R5k</b>					
<b>10 kOhm</b>		<b>R10k</b>					
<i>Option 20 kOhm</i>		<i>R20K</i>					
<i>Option 50 kOhm</i>		<i>R50K</i>					
<i>Option 100 kOhm</i>		<i>R100K</i>					
<i>Option rear shaft:</i>							
<i>Standard Ø1,00 x 10 mm</i>				<i>RA</i>			
<i>Shaft length in mm</i>				<i>RAxx,xx</i>			
<b>Resistance tolerance:</b>							
<b>±10%</b>					<b>W10%</b>		
<i>Option ±15%</i>					<i>W15%</i>		
<b>Independent linearity:</b>							
<b>±1,00%</b>						<b>L1%</b>	
<i>Option ±2%</i>						<i>L2%</i>	
<i>Option center tap:</i>							<i>CT</i>
<b>Option front shaft:</b>							
<b>Standard Ø3,00 x 11,5 mm</b>							-
<i>Option Ø 3,175 x 11,5 mm</i>							<i>DM3,175</i>
<i>Option shaft length in mm</i>							<i>Ax,xx</i>
<i>Option shaft diameter in mm (≤3,175 mm)</i>							<i>DMx,xx</i>

**For higher quantities or on-going demand, additional options are available as described below on request**

For Example: With mech. end stop 310° @ 30 Ncm, special electrical angles of rotation, and special resistance and linearity tolerances. Furthermore we can mount gear wheels or attach cable assemblies with or without connectors and much more.

# Data Sheet for Precision Potentiometer



Conductive Plastic Potentiometer

Series MCP05

## Drawing

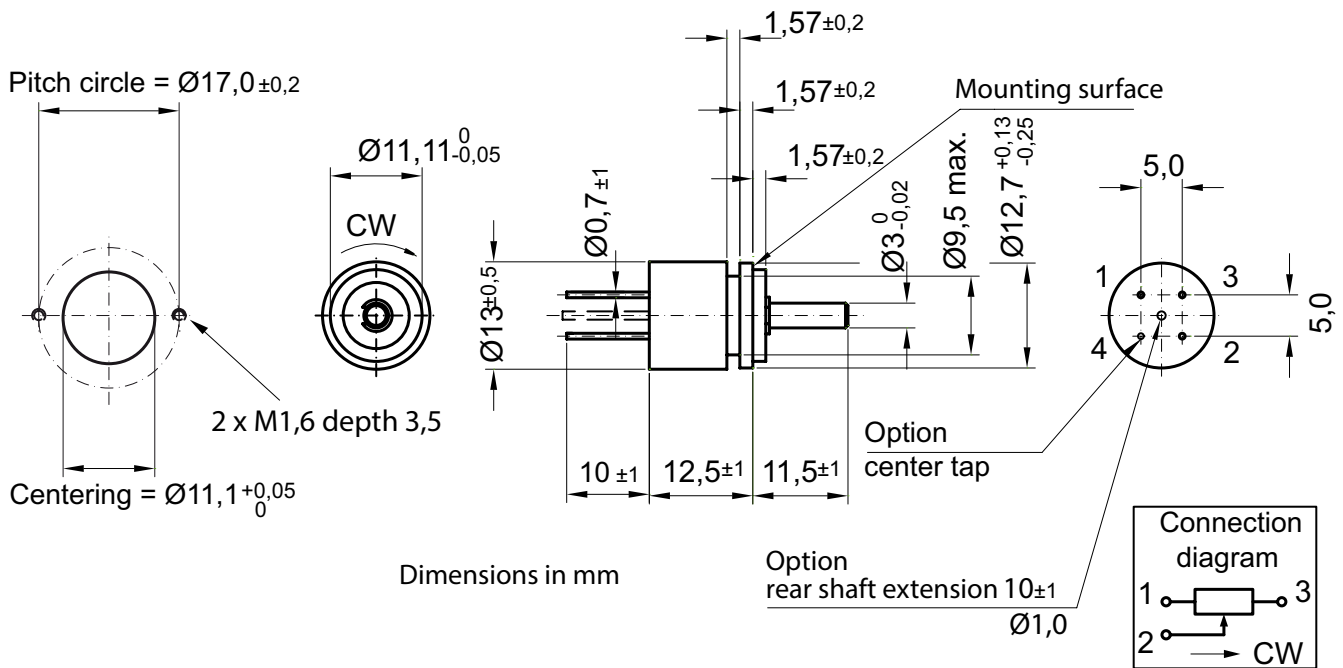

### On Request: Special machining on shaft

Slot

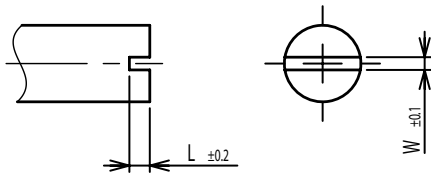

Groove

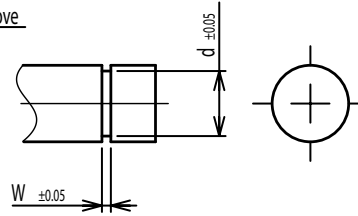

Flat

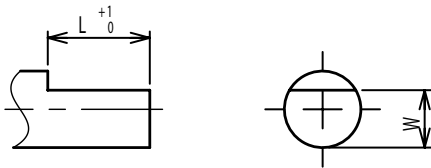

Round top

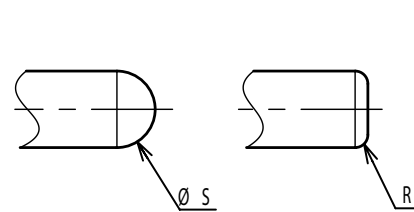

Double side flat

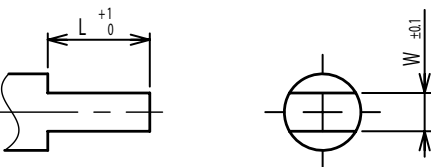

Counterbore hole

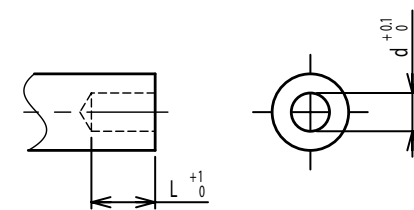

Step

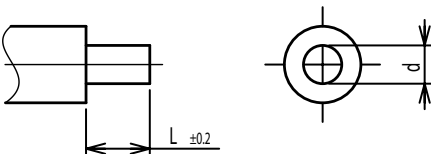

Counterbore screw hole

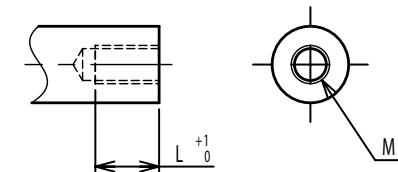

Screw Thread

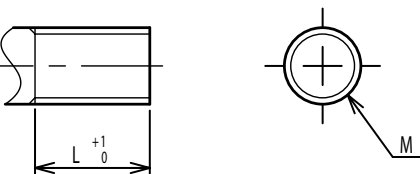

Pin hole

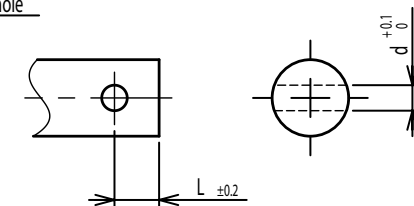

Knurled(Parallel)



Screw thread inside hole

