

# Data Sheet for Precision Potentiometer

Multiturn Hybrid Potentiometer

Series HH17/19



HH(R)17/19  
soldering lugs



HH(R)17/19  
connector

The HH(R)17/19 potentiometers in 22 mm housing are suitable for applications where a long life and very high-resolution multiturn potentiometer is important.

- Very high-resolution and long-lasting due to hybrid technology
- Very clean signal - no winding jumps thanks to hybrid technology
- Simplified installation due to connector version
- Version HHR17/19 with integrated slipping clutch

The high-resolution precision potentiometers of the HH(R)17/19 series have a wire-wound resistor element, which is finished with a conductive plastic layer. Thus the so-called winding jumps are omitted and the resolution is almost infinite. Due to the smooth surface of the resistance element, the hybrid potentiometer has a significantly longer life and qualifies it as a position feedback in closed loop control circuits. The shaft diameters is  $\varnothing 6,35 / \varnothing 6,00$  mm (HH(R)17/HH(R)19) and is equipped with a screwdriver slot. In addition, an optional integrated slipping clutch protects the potentiometer from damage by overrunning the end stops and facilitates the zero point adjustment. The potentiometer is available in a 3, 5 or 10 turn version. The radial gold-plated connection pins are suitable for flat connectors (2.8 mm according to DIN 46247 part 3) and the connector version simplifies the mounting.

Electrical Data	3-turn	5-turn	10-turn
Effective electrical angle of rotation 1.)	1080° ±5°	1800° ±5°	3600° ±5°
Total resistance 1.)	1..50 kOhm	1..50 kOhm	2..100 kOhm
Resistance tolerance		±10% (±5%)	
Independent linearity (best straight line) 1.)	±0,35%	±0,35% (±0,2%)	±0,25% (±0,1%)
Theoretical resolution 1.)		Nearly infinite	
Backlash (Hysteresis) 1.)		≤ 2°	
Max. / recommended wiper current 1.)		10 µA / 2 µA	
Power rating @ 70°C (0W @ 105°C)	0,5 W	1 W	2 W
Insulation Voltage 1.)		1000 VAC, 1min	
Insulation Resistance 1.)		100 MOhm @ 1000 VDC	

Mechanical Data, Environmental Conditions, Miscellaneous	3-turn	5-turn	10-turn
Mechanical angle of rotation	1080° +10°	1800° +10°	3600° +10°
Lifetime (90% el. eff. angle half sine) 2.)	1,5 Mio. rotations	2,5 Mio. rotations	5 Mio. rotations
Max. operational speed		40 rev. / min.	
Bearing		Brass bearing	
Operational torque @ ambient temperature 1.) 2.)		5 Nmm	
End stop torque 1.) 2.)		35 Ncm	
Operating temperature range		-20..+105°C	
Storage temperature range		-55..+105°C	
Protection grade (IEC 60529)		IP40	
Protection option D shaft sealing (IEC 60529)		IP65 optional	
Vibration (IEC 68-2-6, Test Fc)		15g 10..2000Hz x 12h	
Shock (IEC 68-2-27, Test Ea)		49g @ 11 ms x 18	
Housing diameter		22 mm	
Housing depth		19 mm	
Shaft diameter (HH17/19)		6,35 mm / 6,00 mm	
Shaft type		Solid shaft	

# Data Sheet for Precision Potentiometer

Multiturn Hybrid Potentiometer

Series HH17/19

Mechanical Data, Environmental Conditions, Miscellaneous	3-turn	5-turn	10-turn
Max. radial load		≤1 N	
Max. axial load		≤1 N	
Connection type	Gold plated soldering lugs, integrated connector		
Connection position	Radial		
Sensor mounting	Bushing		
Mass	25 g		
Fastening parts included in delivery	Nut, toothed washer		
Fastening torque mounting nut	150 Ncm		
Material shaft	Stainless steel		
Material housing	Reinforced fibreglass PA66		

1.) According IEC 60393

2.) Determined by climatic conditions according to IEC 68-1, para. 5.3.1 without load collectives

Please note: Max. permissible supply voltage <75 VDC respectively <50 VAC in addition the max. power rating must be observed

# Data Sheet for Precision Potentiometer

Multiturn Hybrid Potentiometer

Series HH17/19

## Order code

Description		Selection: standard=black/bold, possible options=grey/cursive									
<b>Series:</b>	<b>HH</b>										
<b>Slipping clutch:</b> Without additional mechanics With integrated slipping clutch	- R										
<b>Shaft diameter:</b> Ø 6,35 mm Ø 6,00 mm				<b>17</b> <b>19</b>							
<b>Revolutions with stop:</b> Option 3-turn Option 5-turn <b>10-turn</b>					<i>03M</i> <i>05M</i> <b>10M</b>						
<b>Resistance value / Option Tandem:</b> Option 1 kOhm (only 3 and 5-turn) Option 2 kOhm <b>5 kOhm</b> <b>10 kOhm</b> Option 20 kOhm Option 50 kOhm Option 100 kOhm (only 10 Turn)						<i>Tandem</i> <i>R1k /1k</i> <i>R2k /2k</i> <b>R5k /5K</b> <b>R10k /10K</b> <i>R20K /20K</i> <i>R50K /50k</i> <i>R100K /100k</i>					
Option rear shaft: HH(R)17 = Ø6,35 x 15 mm HH(R)19 = Ø6,00 x 15 mm Shaft length in mm Shaft diameter in mm (≤6,35 mm)						<i>RA</i> <i>RA</i> <i>RAxx,xx</i> <i>RADMx,xx</i>					
<b>Resistance tolerance:</b> <b>±10%</b> Option ±5%							<b>W10%</b> <i>W5%</i>				
<b>Independent linearity:</b> <b>±0,25% (10 Turn)</b> Option ±0,35% (3 and 5 Turn) Option ±0,10% (10 Turn) Option ±0,20% (5 Turn)							<b>L0,25%</b> <i>L0,35%</i> <i>L0,1%</i> <i>L0,2%</i>				
<b>Electrical connection:</b> <b>With soldering lugs</b> With connector									<b>-</b> <i>ST</i>		
Option center tap: (only 10-turn, not with connector)										<i>CT</i>	
<b>Front shaft:</b> HH(R)17 = Ø6,35 x 20,6 mm HH(R)19 = Ø6,00 x 20,6 mm Option shaft length in mm Option shaft diameter in mm (≤6,35)										<b>-</b> <i>Ax,xx</i> <i>DMx,xx</i>	
<b>Screwdriver slot standard:</b>											<b>-</b>
<b>Shaft sealing:</b> Standard is without sealing Option D with shaft sealing											<b>-</b> <i>D</i>

### For higher quantities or on-going demand, additional options are available as described below on request

For Example: Multi ganged potentiometers (max. 10), increased torque, sealed housing case, special electrical and mechanical angles of rotation, and special resistance and linearity tolerances. Furthermore we can mount gear wheels or attach cable assemblies with or without connectors and much more.

Note: If you choose the slipping clutch (R) and your application is with the shaft directed downwards we strongly recommend to order the bearing in the rear lid too - please choose the series HHI17/19.

# Data Sheet for Precision Potentiometer

Multiturn Hybrid Potentiometer

Series HH17/19

## Drawing

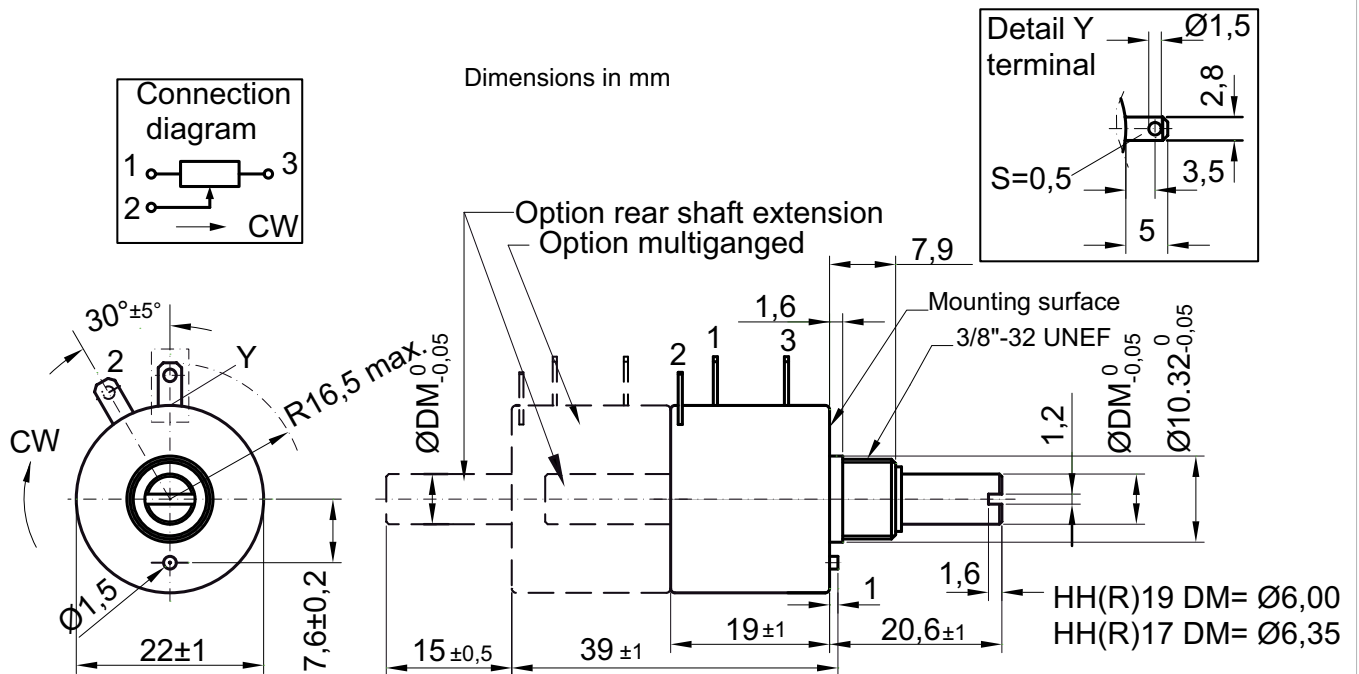

## Connector Version

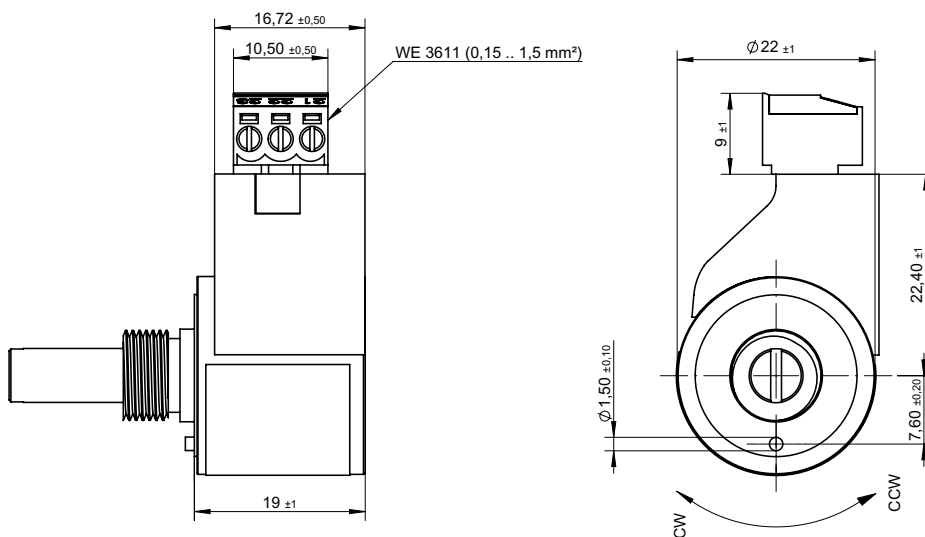

### On Request: Special machining on shaft

Slot

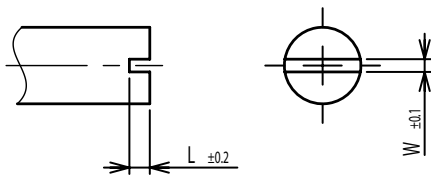

Groove

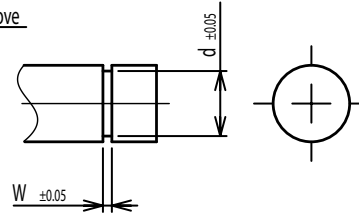

Flat



Round top

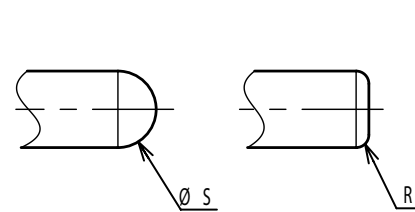

Double side flat



Counterbore hole

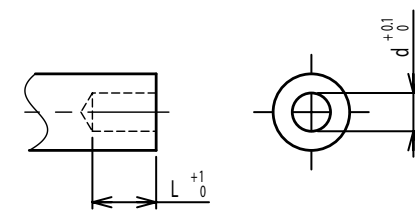

Step



Counterbore screw hole

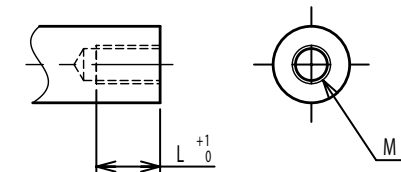

Screw Thread

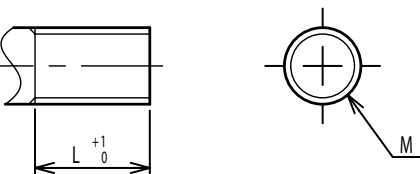

Pin hole

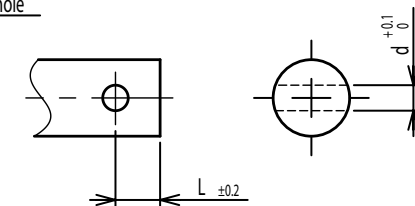

Knurled(Parallel)

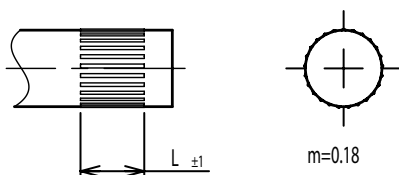

Screw thread inside hole

