

Data Sheet for Precision Potentiometer

Multiturn Hybrid Potentiometer

Series AL14



The potentiometers of AL14 series are for applications where a very accurate and compact multiturn potentiometer with only Ø13 mm housing and servo flange is required.

- Long life span
- Compact construction

The precision potentiometers of the AL14 series have a very compact design. The high-quality hybrid technology and ball-bearing guarantee a life span of more than 10 million shaft revolutions. Due to the very good accuracy, the multi-turn potentiometer is used, for example, in measuring machines or in semiconductor manufacturing.

Electrical Data	5-turn	10-turn
Effective electrical angle of rotation 1.)	1800° ±5°	3600° ±5°
Total resistance 1.)	2 kOhm..50 kOhm	2 kOhm..100 kOhm
Resistance tolerance	±10% (±5%)	
Independent linearity (best straight line) 1.)	±0,4% (±0,1%) [±0,2% R< 5k]	
Theoretical resolution 1.)	Nearly infinite	
Backlash (Hysteresis) 1.)	< 2°	
Max. / recommended wiper current 1.)	10 µA / 2 µA	
Power rating @ 70°C (0W @ 105°C)	0,75 W	1 W
Insulation Voltage 1.)	1000 VAC, 1min	
Insulation Resistance 1.)	1000 MOhm @ 500 VDC	

Mechanical Data, Environmental Conditions, Miscellaneous	3-turn	5-turn
Mechanical angle of rotation	1800° +15°	3600° +15°
Lifetime (90% el. eff. angle half sine) 2.)	5 Mio. rotations	10 Mio. rotations
Max. operational speed	40 rev. / min.	
Bearing	Ball bearing	
Operational torque @ ambient temperature 1.) 2.)	2 Nmm	
End stop torque 1.) 2.)	15 Ncm	
Operating temperature range	-55..+105°C	
Storage temperature range	-55..+105°C	
Protection option D shaft sealing (IEC 60529)	IP40	
Vibration (IEC 68-2-6, Test Fc)	15g 10..2000Hz x 12h	
Shock (IEC 68-2-27, Test Ea)	49g bei 11 ms x 18	
Housing diameter	13 mm	
Housing depth	28,2 mm	
Shaft diameter	3,175 mm	
Shaft type	Solid shaft	

Data Sheet for Precision Potentiometer

Multiturn Hybrid Potentiometer

Series AL14

Mechanical Data, Environmental Conditions, Miscellaneous	5-turn	10-turn
Max. radial load	≤1 N	
Max. axial load	≤1 N	
Connection type	Solder lugs	
Connection position	Radial	
Sensor mounting	Servo flange	
Mass	ca. 10 g	
Fastening parts included in delivery	2 x servo clamps SFN3	
Material shaft	Stainless steel	
Material housing	Plastic	

1.) According IEC 60393

2.) Determined by climatic conditions according to IEC 68-1, para. 5.3.1 without load collectives

Please note: Max. permissible supply voltage <75 VDC respectively <50 VAC in addition the max. power rating must be observed

Data Sheet for Precision Potentiometer

Multiturn Hybrid Potentiometer

Series AL14

Order code						
Description	Selection: standard=black/bold, possible options=grey/cursive					
Series:	AL14					
Revolutions with stop:						
5-turn		5				
10-turn		10				
Resistance value:						
<i>Option 2 kOhm</i>			<i>R2k</i>			
5 kOhm			R5k			
10 kOhm			R10k			
<i>Option 20 kOhm</i>			<i>R20K</i>			
<i>Option 50 kOhm</i>			<i>R50K</i>			
<i>Option 100 kOhm (only 10 Turn)</i>			<i>R100K</i>			
Resistance tolerance:						
±10%				W10%		
<i>Option ±5%</i>				<i>W5%</i>		
Independent linearity:						
±0,4%					L0,4%	
<i>Option ±0,2% (R < 5kOhm)</i>					<i>L0,2%</i>	
<i>Option ±0,1% (R ≥ 5kOhm)</i>					<i>L0,1%</i>	
Front shaft:						
Standard Ø3,175 x 9,525 mm						-
<i>Option Ø3,175 x 11,5 mm</i>						<i>A11,5</i>
<i>Option shaft length in mm</i>						<i>Ax,xx</i>
<i>Option shaft diameter in mm (≤3 mm)</i>						<i>DMx,xx</i>

For higher quantities or on-going demand, additional options are available as described below on request

For Example: Sealed housing case (+1,8 mm housing length), version for PCB mounting, special electrical and mechanical angles of rotation, and special resistance and linearity tolerances. Furthermore we can mount gear wheels or attach cable assemblies with or without connectors and much more.

Data Sheet for Precision Potentiometer



Multiturn Hybrid Potentiometer

Series AL14

Drawing

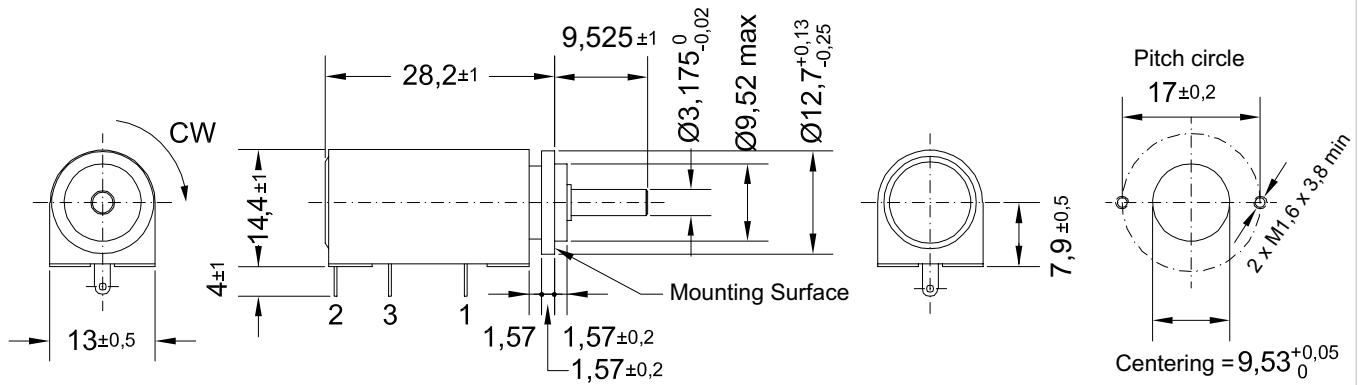

Connection diagram

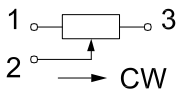

Dimension in mm

On Request: Special machining on shaft

Slot



Groove



Flat



Round top

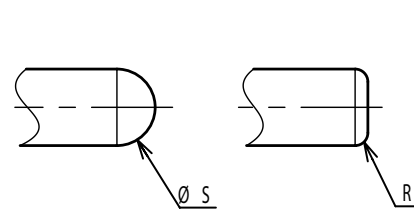

Double side flat

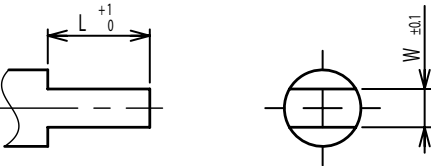

Counterbore hole

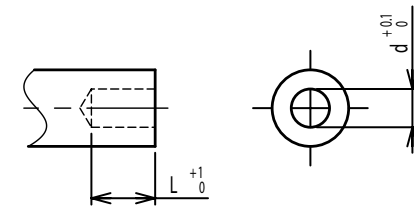

Step

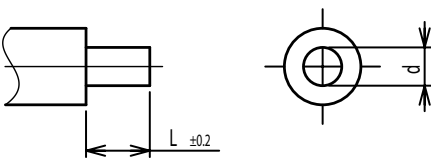

Counterbore screw hole

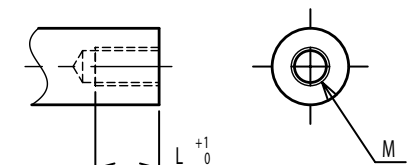

Screw Thread

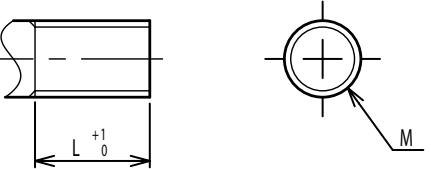

Pin hole

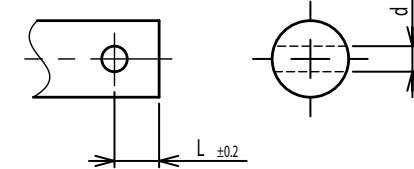

Knurled(Parallel)

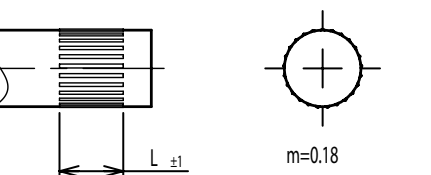

Screw thread inside hole

