

# Data Sheet for Precision Potentiometer

Multiturn Wirewound Potentiometer

Series 21



The Series 21 potentiometers are for applications that require an accurate multi-turn wirewound potentiometer with 2 precision ball bearings and servo flange.

- Servo flange for precise installation
- 2 precision ball bearings
- On request with limit switch

Electrical Data	3-turn	5-turn	10-turn
Effective electrical angle of rotation 1.)	1080° ±5°	1800° ±5°	3600° ±5°
Total resistance 1.)	100 Ohm..50 kOhm	100 Ohm..100 kOhm	100 Ohm..150 kOhm
Resistance tolerance	±3% (±1%)		
Independent linearity (best straight line) 1.)	±0,25%		
Theoretical resolution 1.)	Depends on resistance value (see table below)		
Backlash (Hysteresis) 1.)	≤ 2°		
Rotational noise (ENR) 1.) (Method C)	100 Ohm		
Max. / recommended wiper current 1.)	35 mA / 2 µA		
Power rating @ 70°C (0W @ 105°C)	0,75 W	1 W	2 W
Insulation Voltage 1.)	1000 VAC, 1min		
Insulation Resistance 1.)	100 MOhm @ 1000 VDC		

Mechanical Data, Environmental Conditions, Miscellaneous	3-turn	5-turn	10-turn
Mechanical angle of rotation	1080° +10°	1800° +10°	3600° +10°
Lifetime (90% el. eff. angle half sine) 2.)	0,6 Mio. rotations	1 Mio. rotations	2 Mio. rotations
Max. operational speed	40 rev. / min.		
Bearing	2 x ball bearing		
Operational torque @ ambient temperature 1.) 2.)	3 Nmm		
End stop torque 1.) 2.)	60 Ncm		
Operating temperature range	-20..+105°C		
Storage temperature range	-55..+105°C		
Protection grade (IEC 60529)	IP40		
Vibration (IEC 68-2-6, Test Fc)	15g 10..2000Hz x 12h		
Shock (IEC 68-2-27, Test Ea)	49g @ 11 ms x 18		
Housing diameter	20 mm		
Housing depth	24,5 mm		32 mm
Shaft diameter (HH17/19)	3,00 mm		
Shaft type	Solid shaft		

# Data Sheet for Precision Potentiometer

Multiturn Wirewound Potentiometer

Series 21

Mechanical Data, Environmental Conditions, Miscellaneous	3-turn	5-turn	10-turn
Max. radial load	≤1 N		
Max. axial load	≤1 N		
Connection type	Gold plated soldering lugs		
Connection position	Radial		
Sensor mounting	Servo flange		
Mass	25 g		30 g
Fastening parts included in delivery	3 x servo clamps SFN2		
Material shaft	Stainless steel		
Material housing	Plastic		

1.) According IEC 60393

2.) Determined by climatic conditions according to IEC 68-1, para. 5.3.1 without load collectives

Please note: Max. permissible supply voltage <75 VDC respectively <50 VAC in addition the max. power rating must be observed

Number of wire turns / resolution											
Resistance value Ohm	100	200	500	1k	2k	5k	10k	20k	50k	100k	150k
Number of wire turns 3 Turn	N/A	N/A	N/A	N/A	N/A	N/A	N/A	N/A	N/A	-	-
Number of wire turns 5 Turn	1100	1500	2000	2500	2400	3200	3900	4800	5500	6500	-
Number of wire turns 10 Turn	1800	2200	3200	4000	5000	5000	6400	7800	10000	11000	N/A

Resolution in degree E.g. R5k 5-turn =  $1800^\circ / 3200 = 0,563^\circ$  per winding resistive wire

# Data Sheet for Precision Potentiometer

Multiturn Wirewound Potentiometer

Series 21

## Order code

Description	Selection: <b>standard=black/bold</b> , possible options= <i>grey/italic</i>									
<b>Series</b>	<b>21</b>									
<b>Revolutions with stop:</b> <i>Option 3-turn</i>		<i>03</i>								
<b>5-turn</b>		<b>05</b>								
<b>10-turn</b>		<b>10</b>								
<b>Slipping clutch:</b> <b>Without additional mechanics</b> <i>Option with integr. slipping clutch</i>				- R						
<b>Resistance value / Option Tandem:</b> <i>Option 100 Ohm</i> <i>Option 200 Ohm</i> <i>Option 500 Ohm</i> <b>1 kOhm</b> <i>Option 2 kOhm</i> <b>5 kOhm</b> <b>10 kOhm</b> <i>Option 20 kOhm</i> <i>Option 50 kOhm</i> <i>Option 100 kOhm (not 3 Turn)</i> <i>Option 150 kOhm (only 10 Turn)</i>						<i>Tandem</i> R100 /100 R200 /200 R500 /500 <b>R1k</b> /1k R2k /2k <b>R5k</b> /5k <b>R10k</b> /10k R20k /20k R50k /50k R100k /100k R150k /150k				
<i>Option rear shaft:</i> <i>Standard Ø3,00 x 10 mm</i> <i>Shaft length in mm</i> <i>Shaft diameter in mm (≤3,00 mm)</i>								RA RAxx,xx RADMx,xx		
<b>Resistance tolerance:</b> <b>±3%</b> <i>Option ±1%</i>									<b>W10%</b> W5%	
<b>Independent linearity:</b> <b>±0,25%</b>										<b>L0,25%</b>
<i>Option center tap:</i>										CT
<b>Front shaft:</b> <b>Standard Ø3,00 x 16,5 mm</b> <i>Option shaft diameter 3,175 mm</i> <i>Option shaft length in mm</i> <i>Option shaft diameter in mm (≤6,35 mm)</i>										- DM3,175 Ax,xx DMx,xx

### For higher quantities or on-going demand, additional options are available as described below on request

For Example Limit switch:

Type CW+CCW ("n"=number Turns): LS"n"202

Type CCW ("n"=number Turns): LS"n"201

Type CW ("n"=number Turns): LS"n"203

Or multi ganged potentiometers (max. 2), special electrical and mechanical angles of rotation, and special resistance and linearity tolerances. Furthermore we can mount gear wheels or attach cable assemblies with or without connectors and much more.

# Data Sheet for Precision Potentiometer

Multiturn Wirewound Potentiometer

Series 21

## Drawing

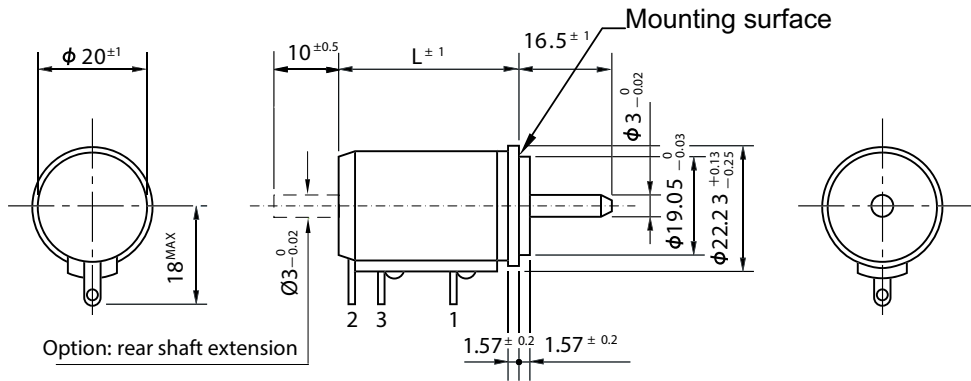

Pitch circle A =  $\phi 29,5_{\pm 0.2}$

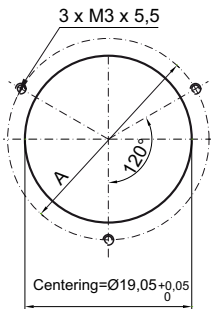

Model	L
21-3/5	24.5
21-10	32

Dimension in mm

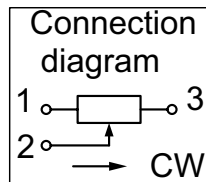

On request: limit switch

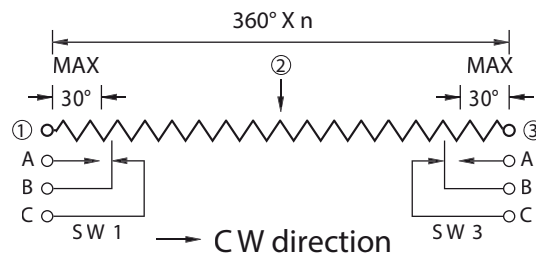
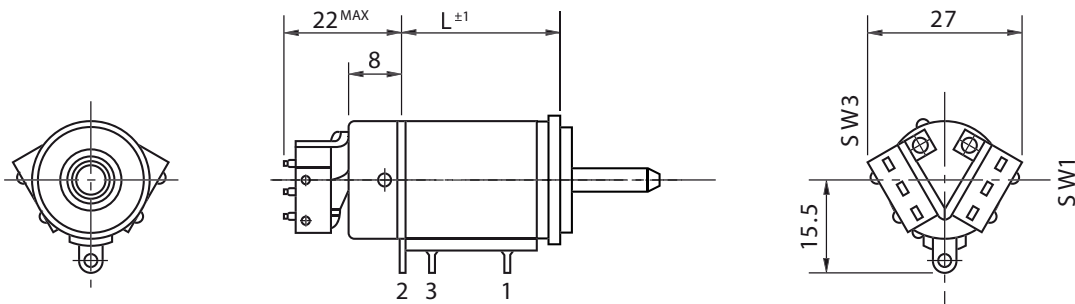

- Unless otherwise specified, the limit-switch is of inscription type on both ends.
- Rating of limit-switch 1A, 125V.A.C. (resistance load)
  - Life expectancy of limit-switch: 50,000 operations
  - Operating temperature range: -55° C..+105° C

### On Request: Special machining on shaft

Slot

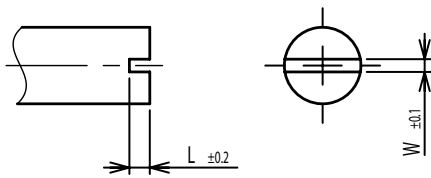

Groove

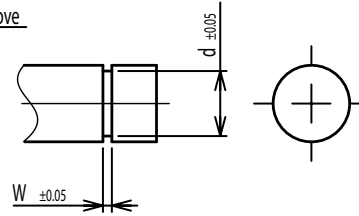

Flat

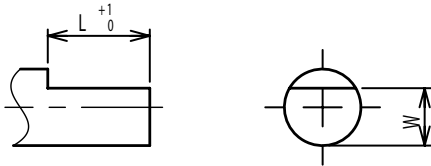

Round top

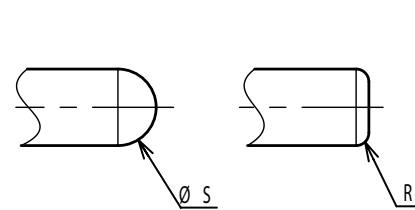

Double side flat

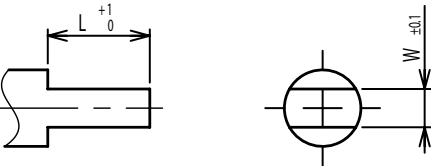

Counterbore hole

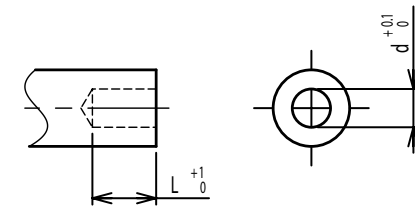

Step

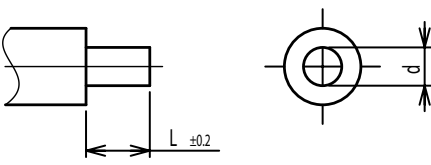

Counterbore screw hole

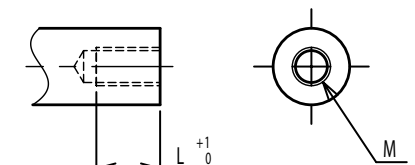

Screw Thread

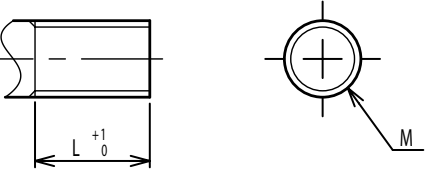

Pin hole

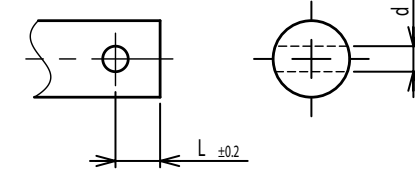

Knurled(Parallel)

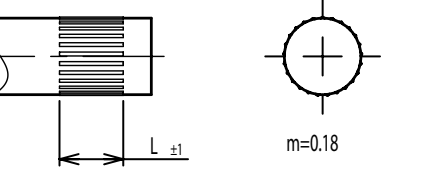

Screw thread inside hole

