

Data sheet for Load Cells

Button Load Cells

Series KMB76



- Measuring range 0...220 kN
- Strain gauge
- Stainless steel
- Degree of protection IP64
- Calibration including measurement data

Series KMB76 force transducer is a all-purpose compression load cell.

Data load cell

Rated force	220 kN
Rated characteristic value	2,0 mV / V of rated output
Relative error of characteristic value	≤ 15% of rated output
Relative repeatability error	≤ 0,5% of rated output
Relative reversibility error	≤ 0,5% of rated output
Relative linearity error	≤ 0,5% of rated output
Reference straight line	≤ 0,5% of rated output
Relative deviation of zero signal	≤ 0,1% of rated output
Rated displacement	≤ 0,15 mm
Input resistance	700 ± 50 Ω
Output resistance	700 ± 50 Ω
Insulation resistance	≥ 500 MΩ @ 50 VDC
Maximum operating force	≤ 150% of rated force
Rated range of excitation voltage	10 V DC / AC
Operating range of excitation voltage	≤ 20 V DC / AC
Rated temperature range	-50°C .. +90°C
Operating temperature range	0°C .. +70°C
Protection	IP64
Temperature effect on characteristic value	≤ 0,36% of rated output / 10 K
Temperature effect on zero signal	≤ 0,18% of rated output / 10 K
Creep under load	≤ 0,5% of rated output
Cable dimension	4 x AWG26, cable shielded
Cable length from body	ca. 3 m
Body material	Stainless steel
Mass	ca. 1100 g

1.) Terms and definitions acc. directive VDI/VDE/DKD 2638

Data sheet for Load Cells

Button Load Cells

Series KMB76

Order code

Description	Selection: standard=black/bold, possible options=grey/cursive		
Series:	KMB76		
Connecting cable: Cable length 3 m		K	
Rated force: 220 kN			220KN

Accessories (not included in delivery)

Measuring amplifier	IMA2 DMS
----------------------------	----------

Data sheet for Load Cells



Button Load Cells

Series KMB76

Drawing

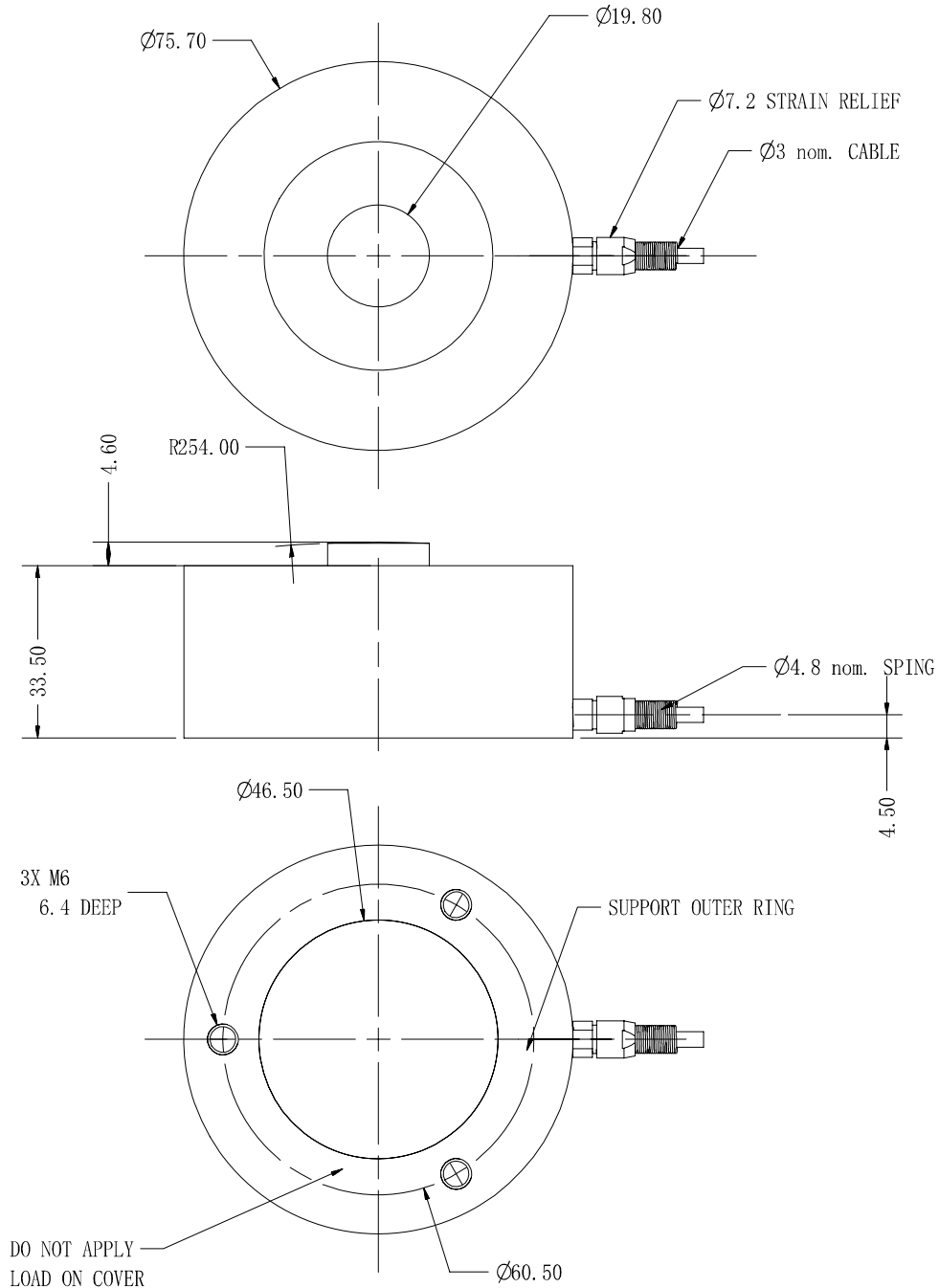

Dimensions in mm

Terminal assignment

Black	- Supply
Red	+ Supply
Green	+ Output
White	- Output