

Data Sheet for Precision Potentiometer

Singleturn Wirewound Potentiometer

Series RPS50



The RPS50 potentiometers with servo flange housings are for applications where a very precise wirewound potentiometer with high electrically effective rotation angle is required.

- Very accurate wirewound potentiometer
- Very high electrically effective angle of rotation $355^\circ \pm 3^\circ$
- On request with mech. end stop (330°)
- Multi-ganged up to 7 gangs
- With many options
- On request with spring return (automatically returning to the zero position)

Electrical Data

Effective electrical angle of rotation 1.)	$355^\circ \pm 3^\circ$
Total resistance 1.)	10 Ohm..50 kOhm
Resistance tolerance	$\pm 3\%$ ($\pm 1\%$)
Independent linearity (best straight line) 1.)	$\pm 0,3\%$ ($\pm 0,1\%$) ($\pm 0,2\%$ $R \leq 2kOhm$ / $\pm 0,1\%$ $R > 2kOhm$)
Theoretical resolution 1.)	Depends on resistance value (see table below)
Backlash (Hysteresis) 1.)	$\leq 0,5^\circ$
Rotational noise (ENR) 1.) (Method C)	100 Ohm
Max. / recommended wiper current 1.)	35 mA / 2 μ A
Power rating @ 70°C (0W @ 105°C)	1,5 W
Insulation Voltage 1.)	1000 VAC, 1min
Insulation Resistance 1.)	1000 MOhm @ 1000 VDC

Mechanical Data, Environmental Conditions, Miscellaneous

Mechanical angle of rotation	360° without stop
Lifetime (90% el. eff. angle half sine) 2.)	1 Mio. rotations
Max. operational speed	40 rev. / min.
Bearing	2 x ball bearing
Operational torque @ ambient temperature 1.) 2.)	5 Nmm
Operating temperature range	-20..+105°C
Storage temperature range	-55..+105°C
Protection grade (IEC 60529)	IP40
Vibration (IEC 68-2-6, Test Fc)	15g 10..2000Hz x 12h
Shock (IEC 68-2-27, Test Ea)	49g @ 11 ms x 18
Housing diameter	50 mm
Housing depth	18 mm
Shaft diameter	6 mm
Shaft type	Solid shaft

Data Sheet for Precision Potentiometer

Singleturn Wirewound Potentiometer

Series RPS50

Mechanical Data, Environmental Conditions, Miscellaneous

Max. radial load	≤1 N
Max. axial load	≤1 N
Connection type	Gold plated soldering lugs
Connection position	Radial
Sensor mounting	Servo flange
Mass	75 g
Fastening parts included in delivery	3 x servo clamps SFN1
Material shaft	Stainless steel
Material housing	Metal

1.) According IEC 60393

2.) Determined by climatic conditions according to IEC 68-1, para. 5.3.1 without load collectives

Please note: Max. permissible supply voltage <75 VDC respectively <50 VAC in addition the max. power rating must be observed

Number of wire turns / resolution

Resistance value Ohm	50	100	200	500	1k	2k	5k	10k	20k	50k
Number of wire turns	500	650	800	1100	1000	1250	1810	2180	2780	3500

Resolution in degree E.g. R5k = $360^\circ / 1810 = 0,199^\circ$ per winding resistive wire

Data Sheet for Precision Potentiometer

Singleturn Wirewound Potentiometer

Series RPS50

Order code

Description

Selection: standard=black/bold, possible options=grey/cursive

Series	RPS50								
Resistance value / Option Tandem:									
Option 10 Ohm		R10	/10						
Option 20 Ohm		R20	/20						
Option 50 Ohm		R50	/50						
Option 100 Ohm		R100	/100						
Option 200 Ohm		R200	/200						
Option 500 Ohm		R500	/500						
1 kOhm		R1k	/1K						
Option 2 kOhm		R2k	/2K						
5 kOhm		R5k	/5K						
10 kOhm		R10k	/10k						
Option 20 kOhm		R20K	/20k						
Option 50 kOhm		R50k	/50k						
Option rear shaft:									
Standard Ø6,00 x 15 mm					RA				
Shaft length in mm					RAxx,xx				
Shaft diameter in mm (≤6 mm)					RADMx,xx				
Resistance tolerance:									
±3%						W3%			
Option ±1%						W1%			
Independent linearity:									
±0,30%							L0,3%		
Option ±0,2% R ≤ 2kOhm							L0,2%		
Option ±0,1% R > 2kOhm							L0,1%		
Option center tap:								CT	
Front shaft:									
Standard Ø6,00 x 31,5 mm								-	
Option front shaft diameter Ø6,35 mm								DM6,35	
Option shaft length in mm								Ax,xx	
Option shaft diameter in mm (≤6,35 mm)								DMx,xx	
Option screwdriver slot:									B

*Housing length +12 mm

For higher quantities or on-going demand, additional options are available as described below on request

For Example: With spring return, multi ganged potentiometers (max. 7) / housing length + 12 mm per gang, more center taps max. 10, with mech. end stop 330° @ 90 Ncm, special electrical and mechanical angles of rotation, and special resistance and linearity tolerances. Furthermore we can mount gear wheels or attach cable assemblies with or without connectors and much more.

Data Sheet for Precision Potentiometer

Singleturn Wirewound Potentiometer

Series RPS50

Drawing

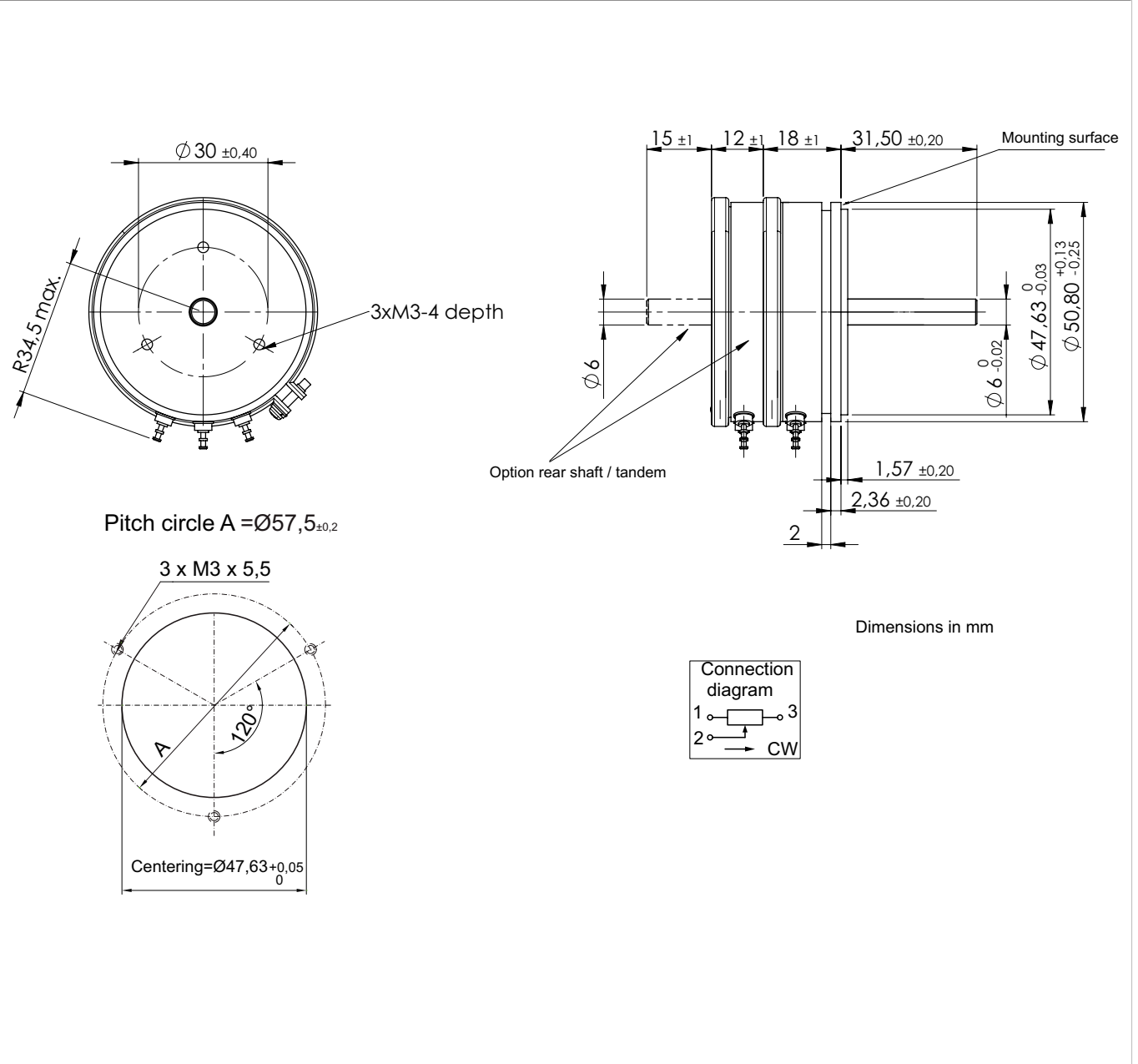

On Request: Special machining on shaft

Slot



Groove



Flat



Round top

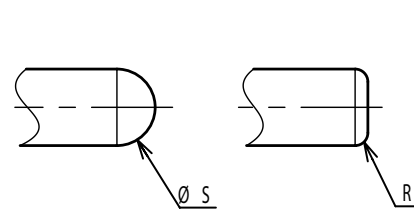

Double side flat

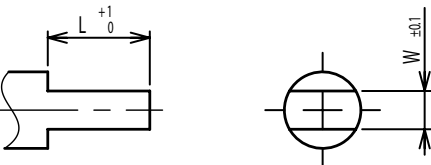

Counterbore hole

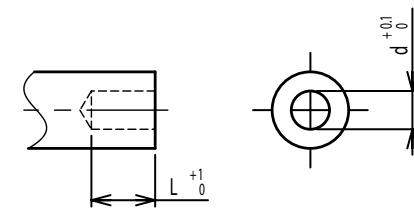

Step



Counterbore screw hole

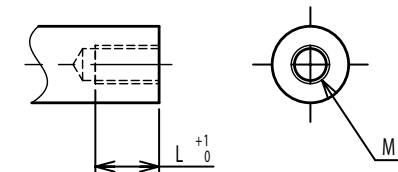

Screw Thread

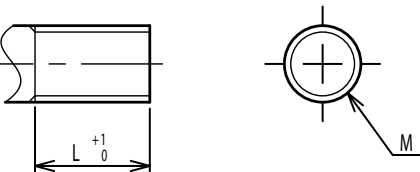

Pin hole

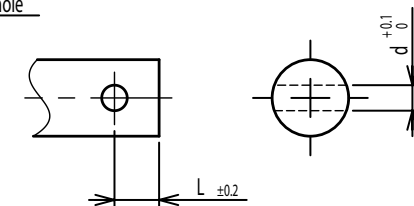

Knurled(Parallel)

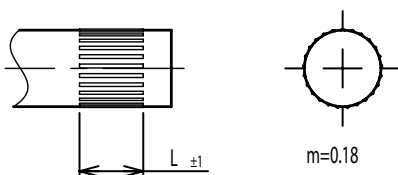

Screw thread inside hole

